



Specification Information

Product Code: 1118

Product Name: Wall Kick Plate

Individual Carton UPC: 624622111809

Individual Carton Shipping Dimensions: 86.4cm W x 2.54cm H x 25.4cm D (34" W x 1" H x 10" D)

Individual Carton Shipping Weight: 2.2kg (5.0 lbs)

Site Location: Frost's 1118 stainless steel wall kick plates are perfect for commercial settings where damage to doors is common. Typically, the product is used in schools/universities, airports, hospitals, restaurants, malls, office buildings, fitness facilities, and recreation centres.

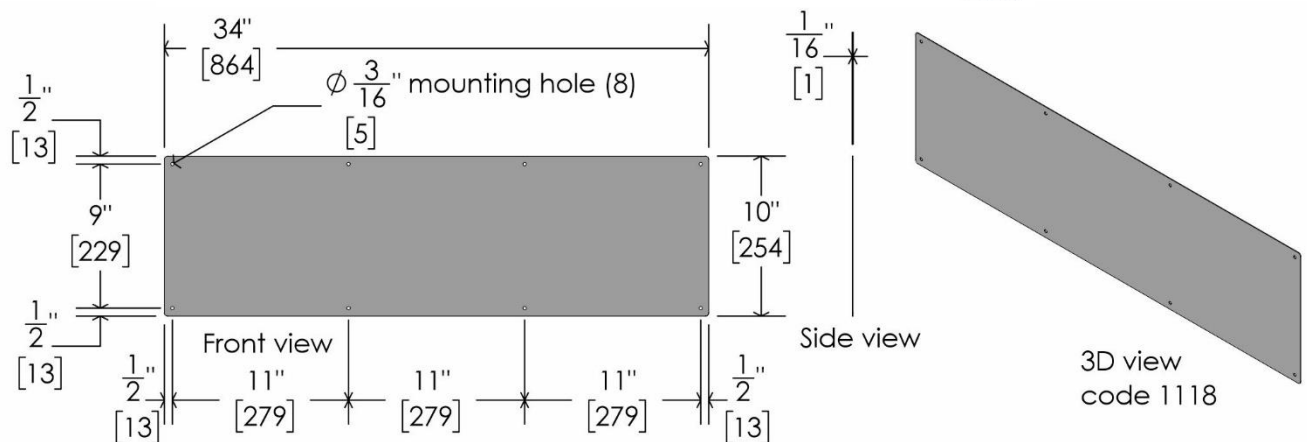

Features:

- Surface mounted
- Easy to install with set of eight mounting screws (included)
- Made from 22 gauge stainless steel
- Type 304 stainless steel, brushed finish
- Canadian made

Materials:

- 22 gauge stainless steel, type 340 brushed finish

Product Dimensions:

- 86.4cm W x 25.4cm H x 1.2cm D (34" W x 10" H x 0.5" D)

Product Weight:

- 2.0 kg (4.5 lbs)

Frost Products Ltd

5276 John Lucas Drive
Burlington, ON, Canada, L7L5Z9

(905) 332-5700
1-800 667-5094

info@frostproductsltd.com
www.frostproductsltd.com



Specification Information

Installation Guidelines: Use holes in kick plate as a template and mark on the wall in its desired location. Use level to ensure straight. Use mounting screws provided to drill kick plate onto wall.

Maintenance: Normal preventative maintenance and cleaning will keep Frost products functioning properly and may extend normal product life. Products should be wiped down with a damp soft cloth periodically. Approved stainless steel cleaner may be used to clean scuffs or fingerprints on stainless surfaces. Do not use harsh detergents or chemical cleaners. For stainless steel please do not spray with any product containing bleach, acids, or chlorides, which can be found in many cleaning products such as toilet bowl cleaners. Use of these cleaning solutions may cause discoloration and if used for prolonged periods of time they can eat away at points in the stainless steel. If discoloration occurs, the use of an approved stainless steel cleaner and a firmer scrub pad, such as a Scotch Brite Pad #7447, may remove the markings. Wipe away any debris from the area and gently rub with the pad. Then spray the area with a stainless steel cleaner/polish and rinse and dry. Always wipe with the grain direction for stainless steel products. If a cleaning agent has begun to eat away at the steel on a unit then the unit will likely need to be replaced. The stainless steel that Frost Products uses is of high quality and stainless steel is resistant to rust. However, discoloration that appears to be rust can be caused by cleaning solutions. It is important to discontinue use of any cleaning agent or soap if discoloration begins to occur. Clean off the discoloration as quickly as possible to avoid any permanent damage to the unit. Maintenance staff should be taught how to recognize the signs that they are not using the appropriate cleaning products and how to correctly maintain stainless steel items.

Warranty: If any product or part proves to be defective within 12 months from date of shipment from the factory it will be repaired or replaced without any charge including freight costs when authorized. Costs resulting from the installation or removal of defective products are not covered under this warranty. Discoloration to stainless steel parts resulting from exposure to harsh environmental and / or chemicals are not considered to be defects in workmanship or material and are not covered under warranty.